

# PLATAFORMA IZARO ECO

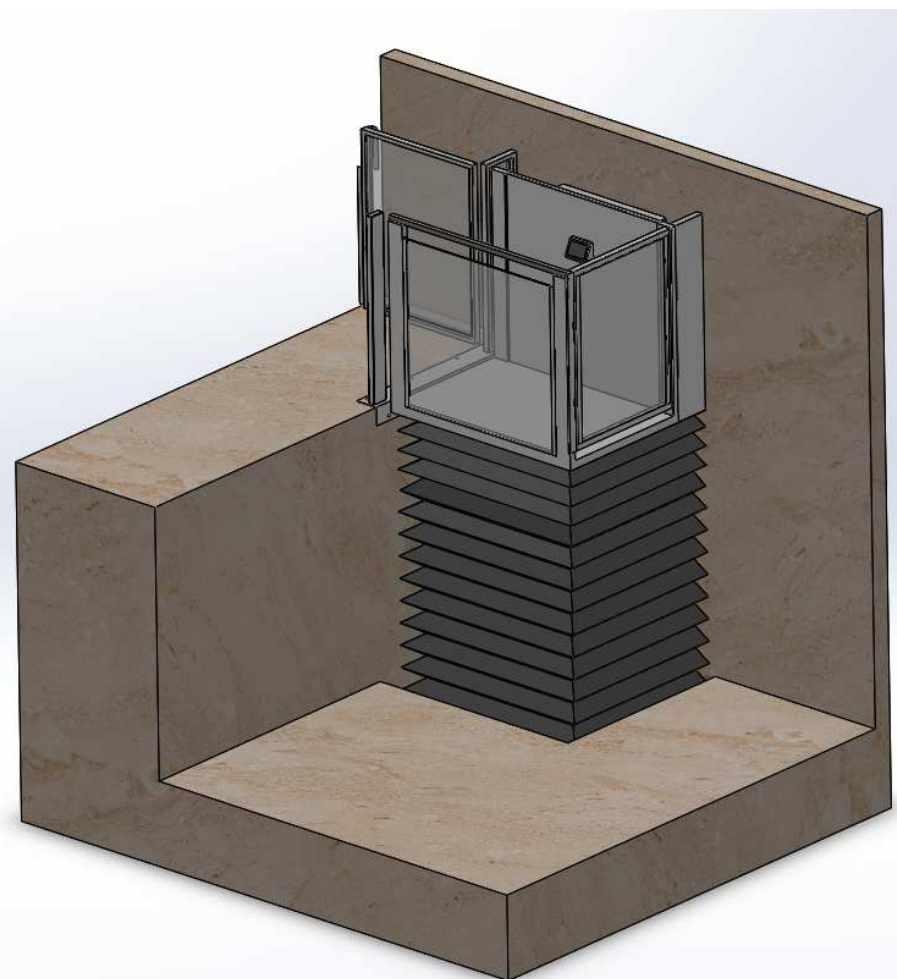

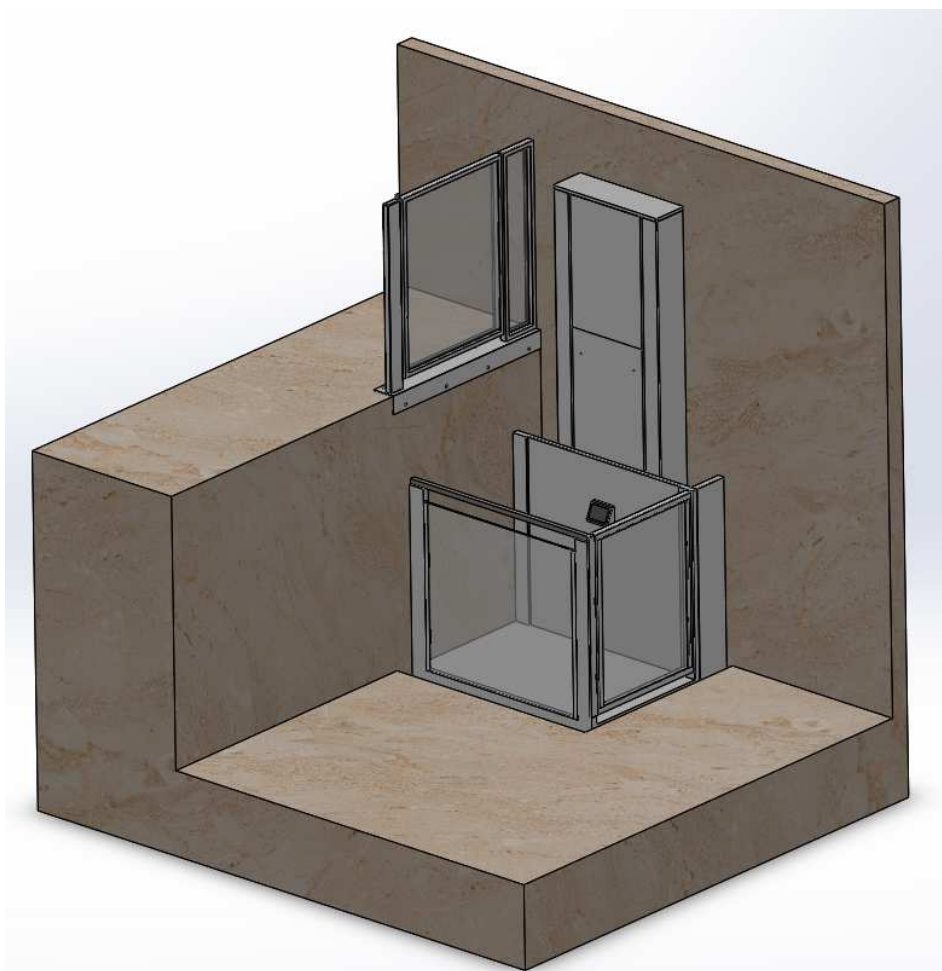

	DISEÑO	1 2 3 4 5 6 7 8 9 10 11 12
	CLAVE	1 2 3 4 5 6 7 8 9 10 11 12
CADA 1000 HORAS	DWG. NR.: 1/28	1 2 3 4 5 6 7 8 9 10 11 12

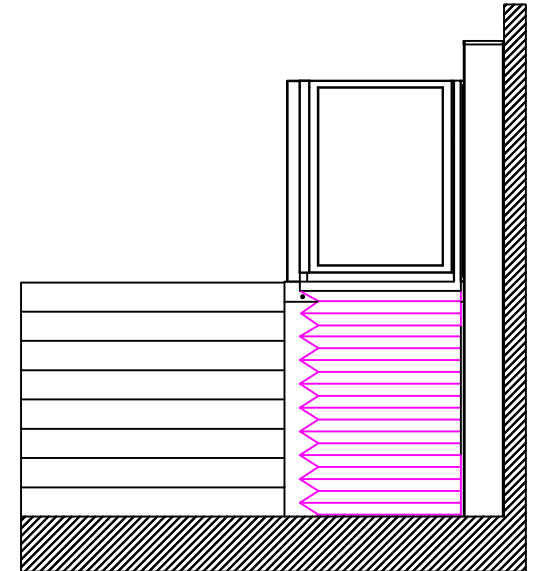
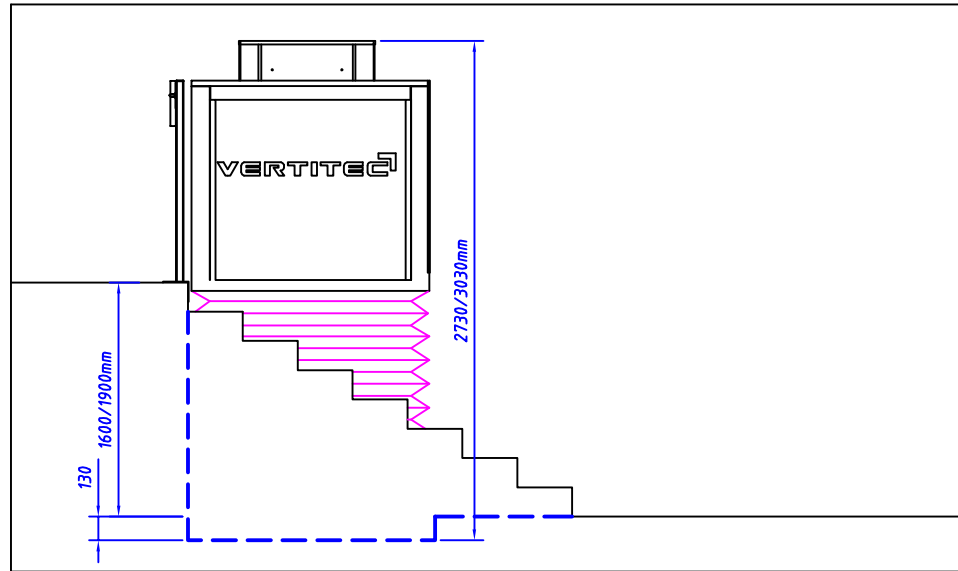
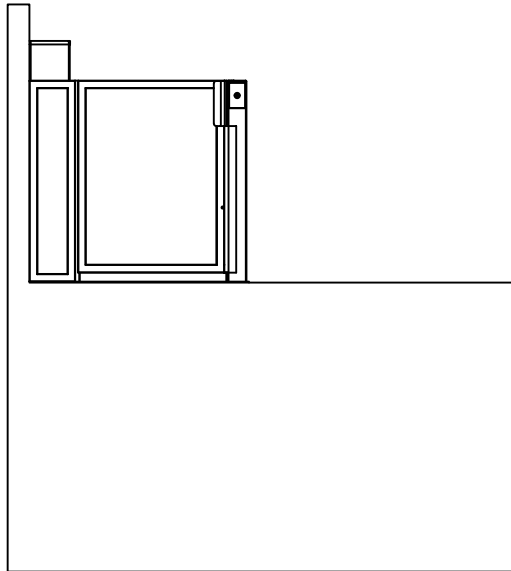
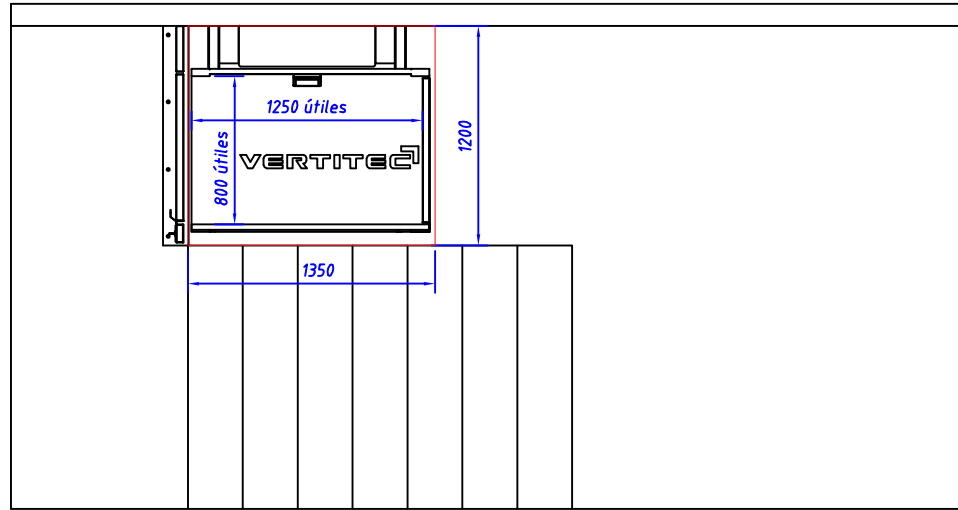
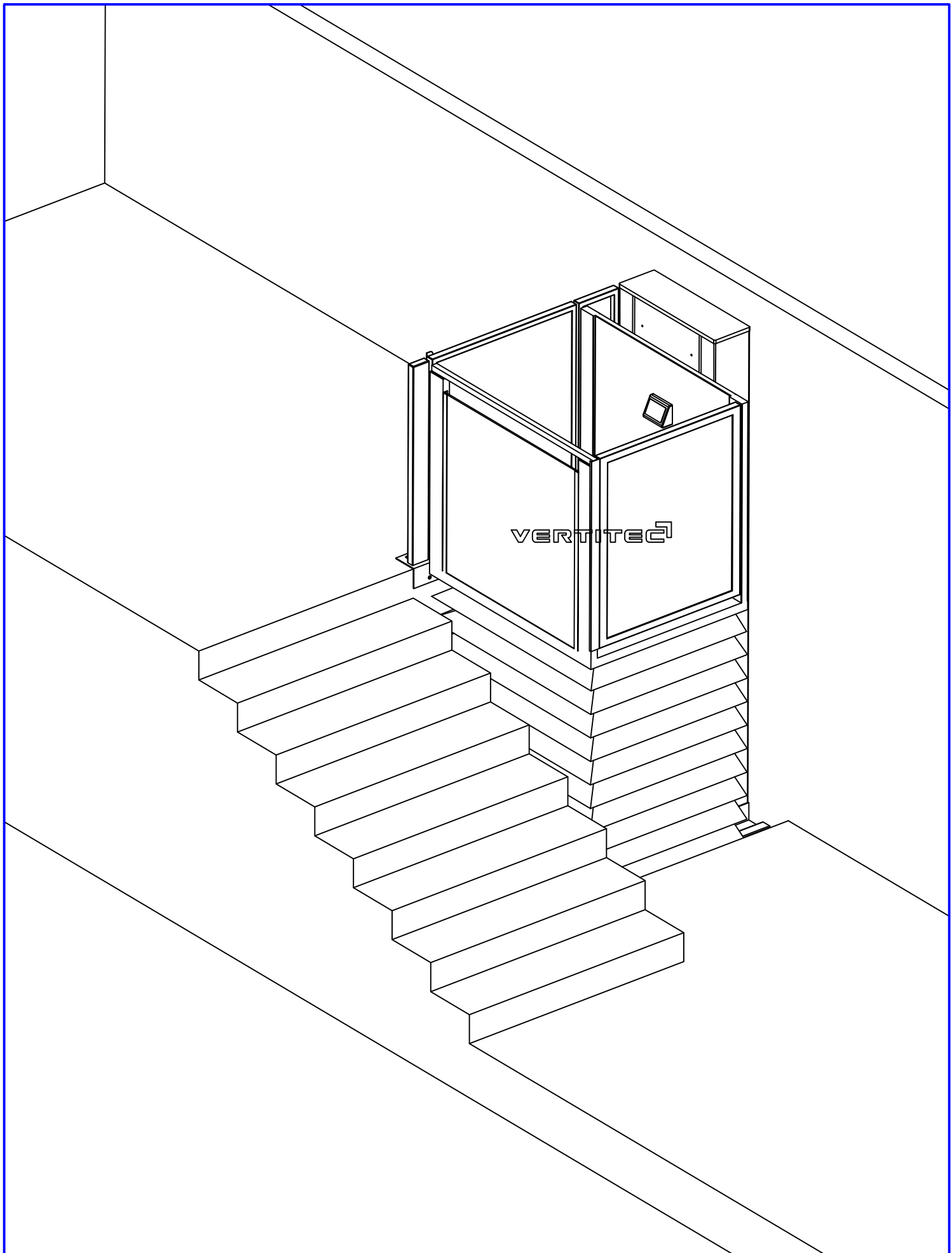

	REFERENZIA	<table border="1"><tr><td>1</td><td></td></tr><tr><td>2</td><td></td></tr><tr><td>3</td><td></td></tr><tr><td>4</td><td></td></tr><tr><td>5</td><td></td></tr><tr><td>6</td><td></td></tr><tr><td>7</td><td></td></tr><tr><td>8</td><td></td></tr><tr><td>9</td><td></td></tr><tr><td>10</td><td></td></tr><tr><td>11</td><td></td></tr><tr><td>12</td><td></td></tr><tr><td>13</td><td></td></tr><tr><td>14</td><td></td></tr><tr><td>15</td><td></td></tr><tr><td>16</td><td></td></tr><tr><td>17</td><td></td></tr><tr><td>18</td><td></td></tr><tr><td>19</td><td></td></tr><tr><td>20</td><td></td></tr></table>	1		2		3		4		5		6		7		8		9		10		11		12		13		14		15		16		17		18		19		20		CLIENTE	DWG. NR. : 2/8
	1																																											
2																																												
3																																												
4																																												
5																																												
6																																												
7																																												
8																																												
9																																												
10																																												
11																																												
12																																												
13																																												
14																																												
15																																												
16																																												
17																																												
18																																												
19																																												
20																																												
UTORI: BRUNO, FELIO, GIOVANNI	PROG. DATA	DESCRIZIONE:																																										

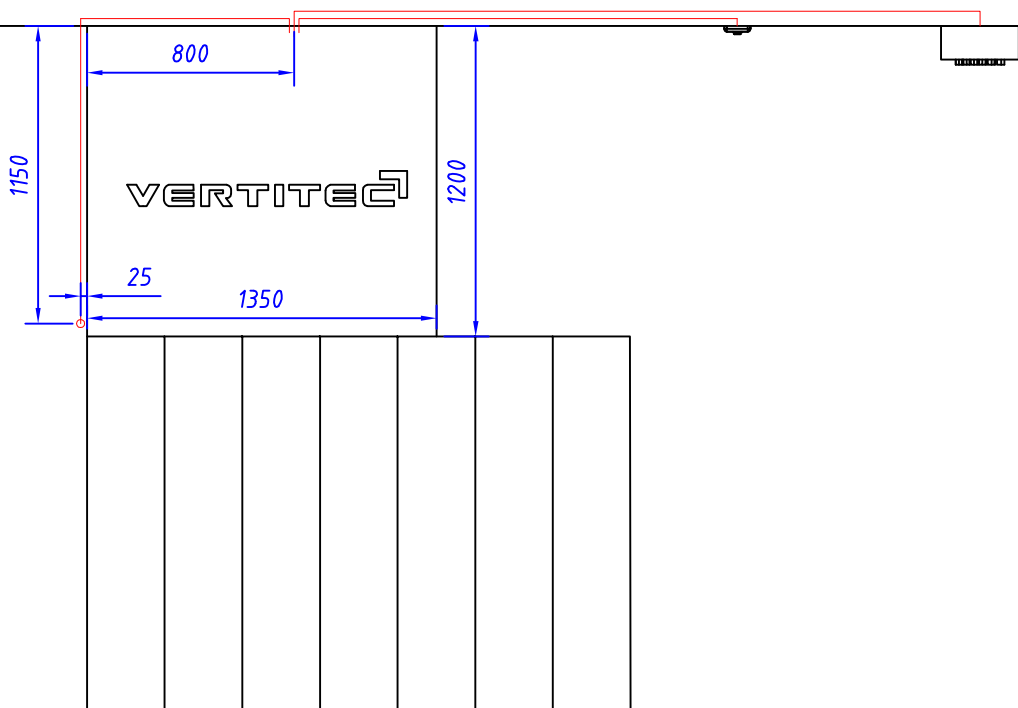
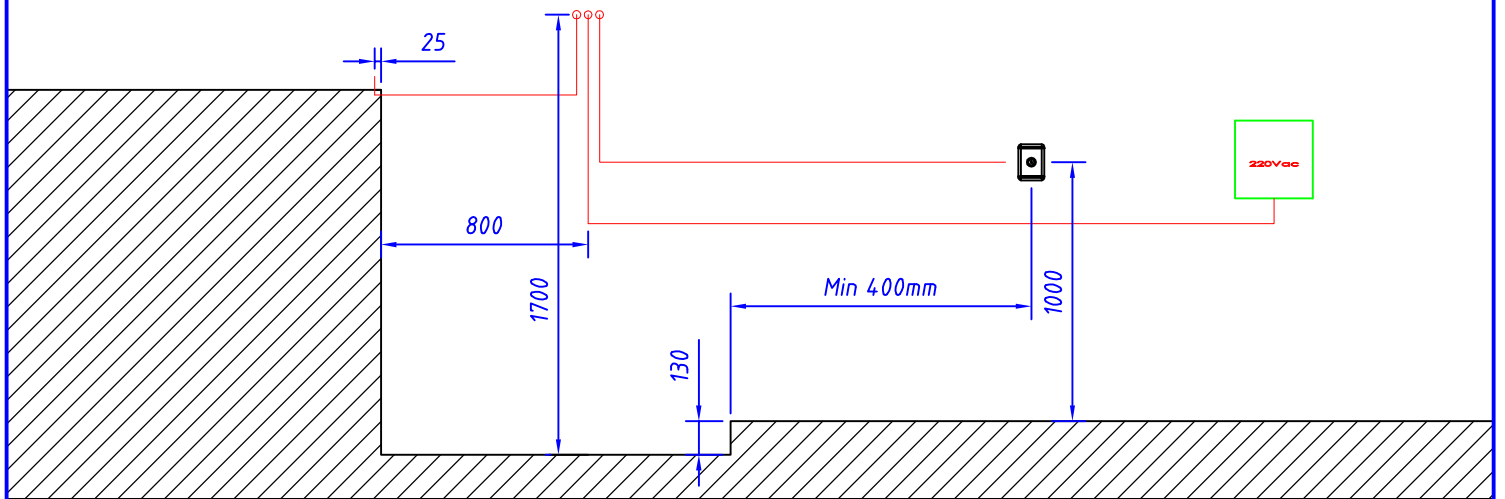

PREPARACION HUECO IZARDO ECD 1250x800 DERECHAS

	REFERENCIA 	1 2 3 4 5 6 7 8 9 10 11 12 13 14 15 16 17 18 19 20 21 22 23 24 25 26 27 28 29 30 31 32 33 34 35 36 37 38 39 40 41 42 43 44 45 46 47 48 49 50 
	CLIENTE 	DWG. NR. : 3/8 
AUTOR: ISLA PEREZ SIBRES 		DISEÑO: * 

Conexión puerta cuadro:  $d = 25\text{mm}$   
Conexión botonera cuadro:  $d = 20\text{mm}$   
Conexión luz: 2P + TT mín 2.5mm

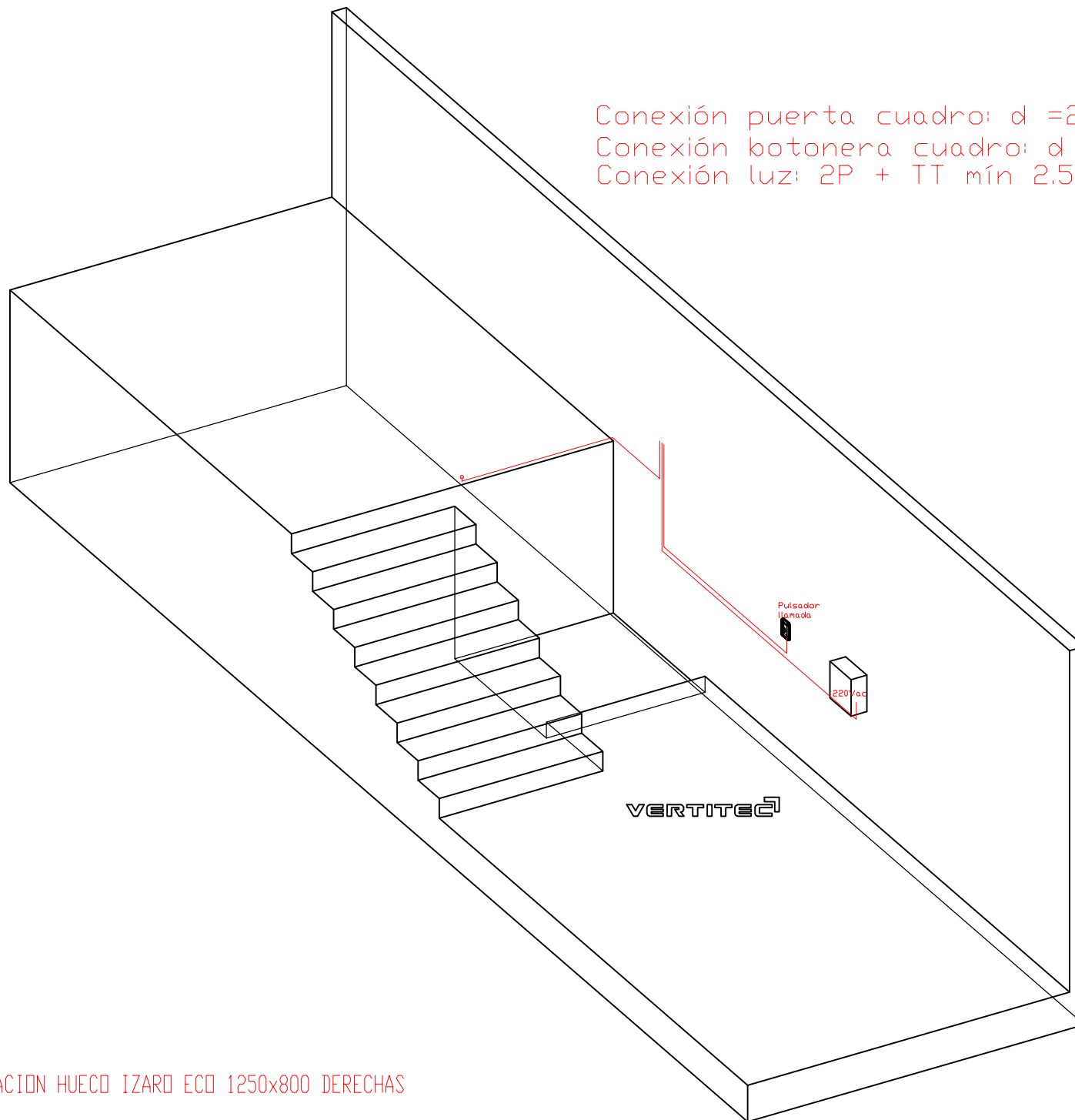

PREPARACION HUECO IZARD ECO 1250x800 DERECHAS

	PROYECTO	
	CLIENTE	
	FECHA	
	PROYECTISTA	
	REVISOR	
	APROBADO	
	FECHA APROBACION	
	ESCALA	
	HOJA	
	TOTAL	
	PROYECTO	
	CLIENTE	
	FECHA	
	PROYECTISTA	
	REVISOR	
	APROBADO	
	FECHA APROBACION	
	ESCALA	
	HOJA	
	TOTAL	

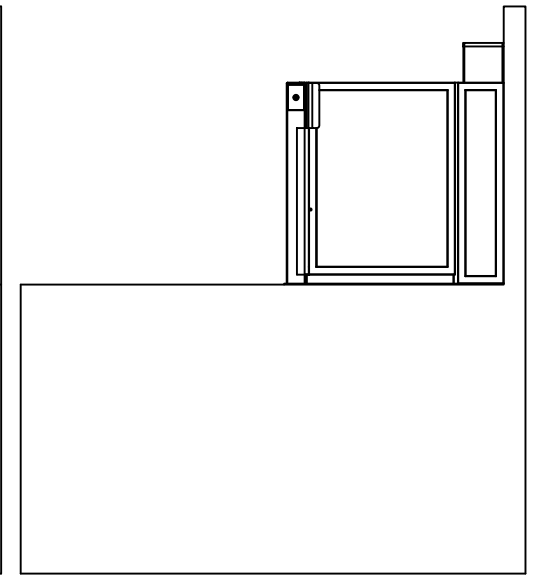
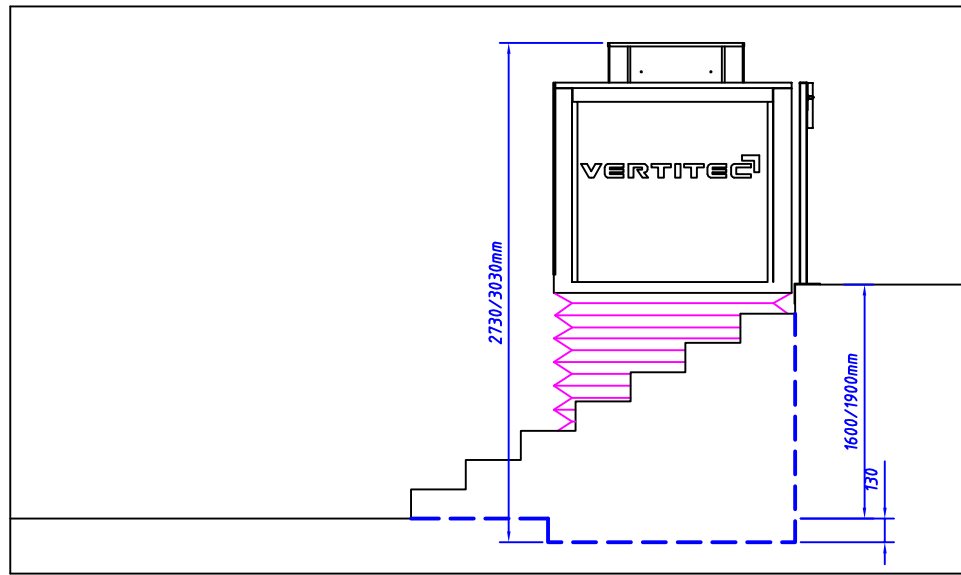
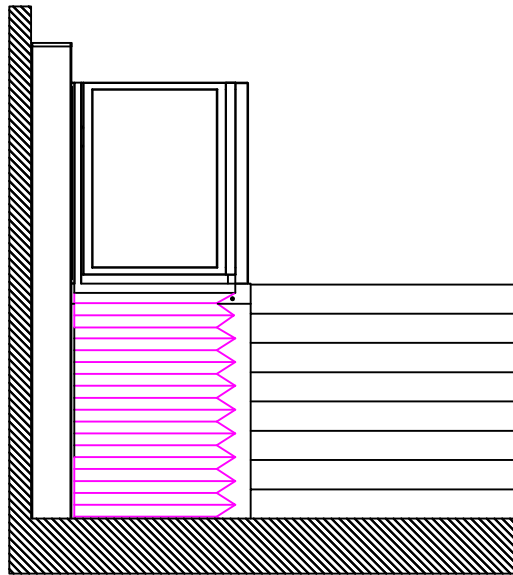
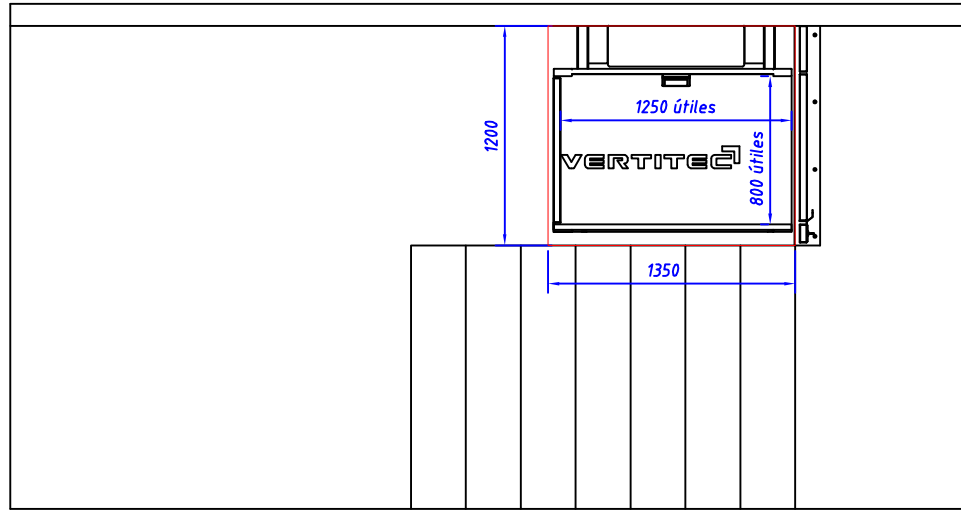

	MODEL:	1 2 3 4 5 6 7 8 9 10 11 12 13 14 15 16 17 18 19 20 21 22 23 24 25 26 27 28 29 30 31 32 33 34 35 36 37 38 39 40 41 42 43 44 45 46 47 48 49 50
	COLOR:	DWG. NR.: 5/28
WWW.VERTITEC.COM	DATE:	DRAWN:

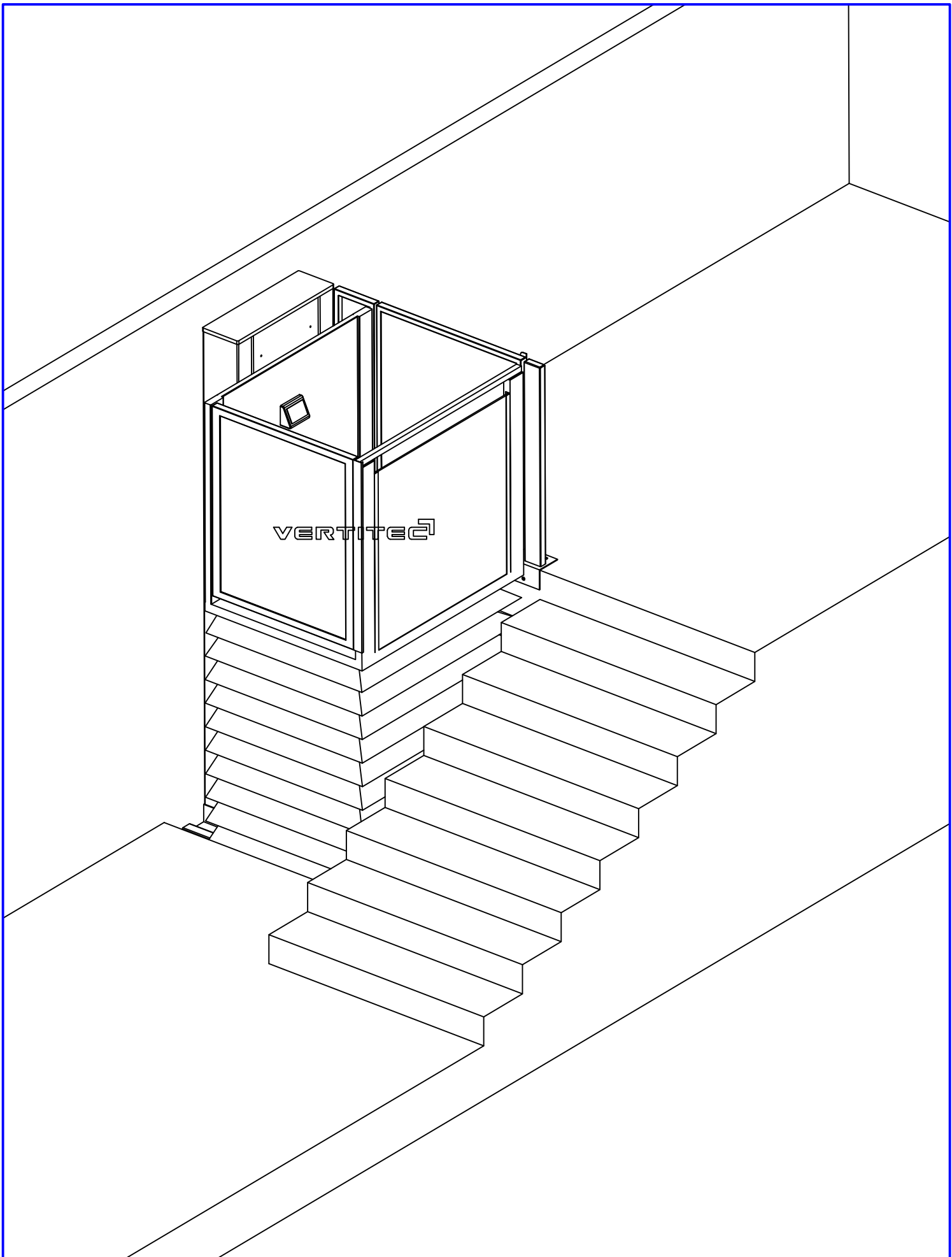

		REFERENZIA	
			VERTITEC
DATE	PRO	CLIENTI	
DWG. NR. : 6/8			
DISEGNO			AUTON. EDIZ. PER SOLO. STORES

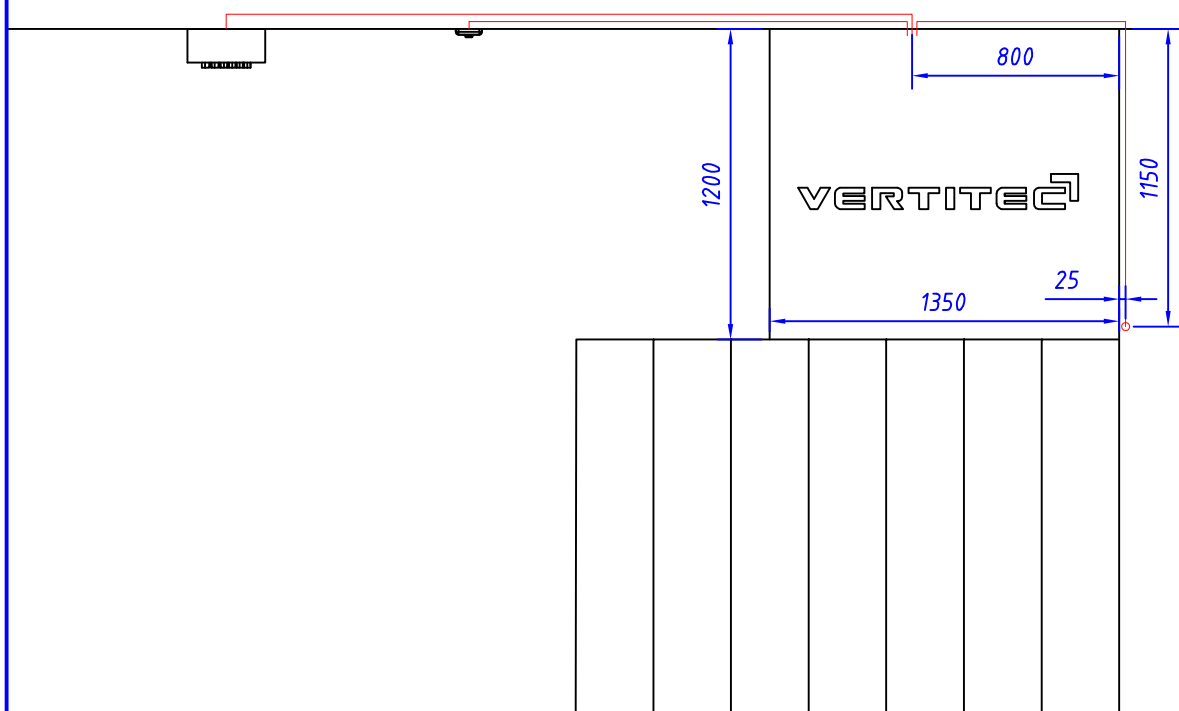
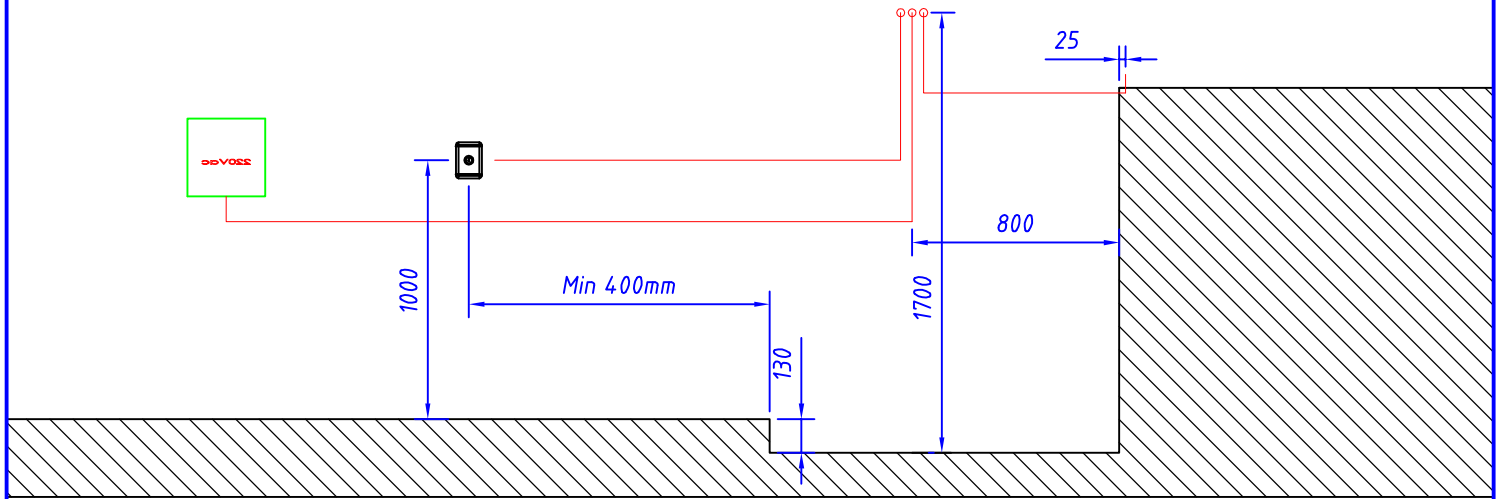

PREPARACION HUECO IZARU ECD 1250x800 IZQUIERDAS

<b>VERTITEC</b>	REFERENCIA:										
	CLIENTE:										
AUTOR: BELLA PÉREZ GÓMEZ		DWG. NR. : 7/8								DISEÑO: *	



Conexión puerta cuadro: d =25mm  
Conexión botonera cuadro: d =20mm  
Conexión luz: 2P + TT mín 2.5mm

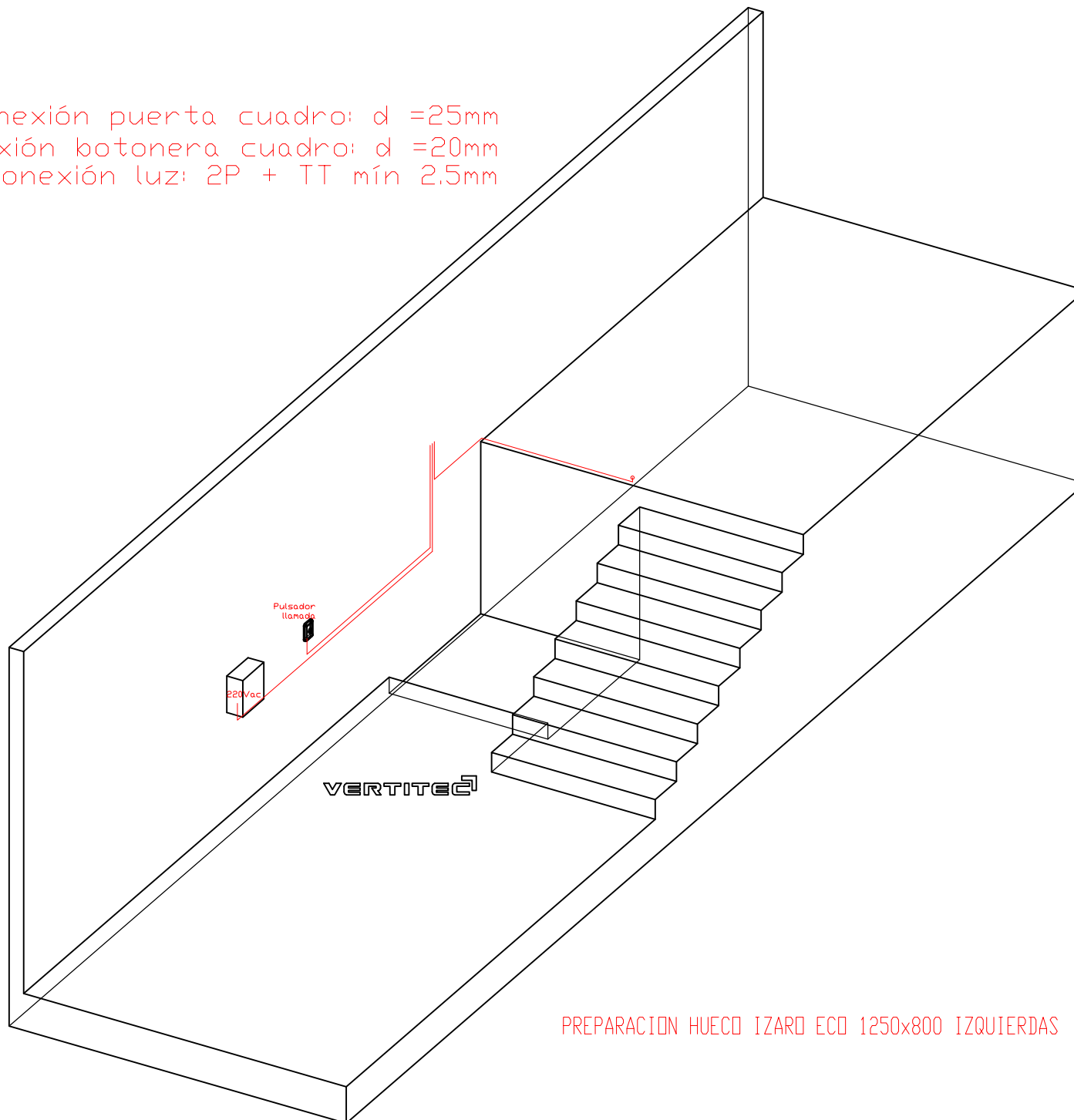

PREPARACION HUECO IZARD ECO 1250x800 IZQUIERDAS

	DESCRIPCIÓN	UNIDAD
	CANTIDAD	VALOR
	CLASE	
	PROYECTO	
	FECHA	
	PROYECTANTE	
	REVISOR	
	APROBADO	
	FECHA APROBACIÓN	
	OTROS DATOS	